

DESCRIPTION

The FXA series flood lights efficiently delivers bright, white light with robust performance. Lumen packages between 8900 and 50,000 lumens to fit all your project needs (See [FXA 15-45W](#) spec for lumens packages from 2000 to 5650 lumens). Its 100,000 hours rated life significantly decreases maintenance costs over the life of the fixture. The FXA has efficacies up to 137 lumens per watt and provides over 70% energy savings compared to HID technology is designed to illuminate landscaping, pathways, building facades, long docks and a wide variety of other outdoor areas needing flood lighting. The FXA is an ideal choice to maximize energy savings and utility rebates.

SPECIFICATIONS

Construction:

- Die-cast aluminum housing in a powder coated finish
- UV stabilized polycarbonate lens
- Integral heat sink maximizes heat dissipation for longer LED life
- Vented housing isolated the driver from the LED compartment, maximizing heat dissipation and fixture life
- Driver compartment sealed with continuous silicone gasket
- Unit includes trunnion mount for 70W-200W models
- Slipfitter accessory available for 70W-200W models
- Yoke mount for 350W model

Optics/LEDs:

- UV-stabilized polycarbonate lens, wide NEMA distribution 7Hx6V (W), optional medium narrow NEMA 4Hx4V (MN) available for 135W-350W configurations
- 70W-350W LED models replace 250W-1000W HID for up to 70% energy savings
- Up to 50,000 lumens for a variety of applications (See [FXA 15-45W](#) spec for lumens packages from 2000 to 5650 lumens)
- Efficacies up to 137 LPW maximize energy savings and utility rebates
- Available in 4000K and 5000K CCT
- L70 >100,000 hours
- CRI ≥70

Electrical:

- Class 2 power supply, 120 to 277VAC, 50/60Hz
- 347/480VAC option (not available for 100W configuration)
- 1-10V dimming driver

Installation:

- Easy installation in new construction or retrofit applications
- Multiple mounting options available to suit your application trunnion (TR) and slipfitter (SF) mount for 70W to 200W
- Yoke mount (YK) for the 350W configuration

Options:

- Factory installed 120/277VAC button type photocontrol (PC)

Accessories:

- Bluetooth enabled dimming occupancy sensor, PIR, black finish ([LE-FXA-BL-KIT](#) or [LE-FXA-BL-12V-KIT](#))
- Button type universal photocontrol 120/277VAC (PCU)
- Slipfitter mount for 70W-200W (SF)

Additional Mounting Accessories:

- Double 180° Bullhorn Mount (AXL2-80/280-BD)
- Wall mount bracket (WM-T-S-BR)
- Wall mount bracket, 90° (AXL2-80/280-W90)

Warranty:

- Five Year Warranty (Terms and Conditions Apply)

Testing & Compliance:

- cULus Listed for Wet Locations
- Tested to meet IP65 requirements

Model: _____ Date: _____
Accessories: _____
Job Name: _____ Type: _____

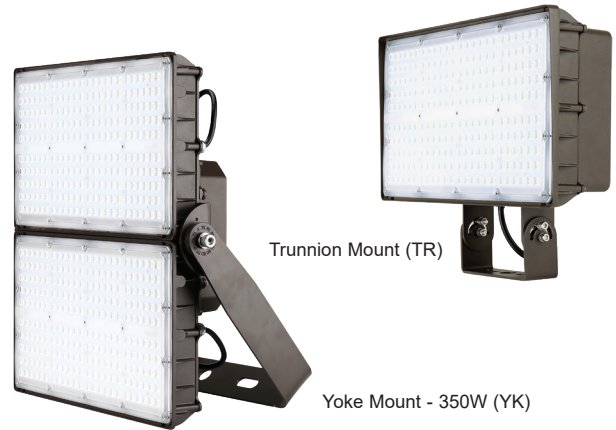

Specs at a Glance*					
Model	FXA-70	FXA-100	FXA-135	FXA-200	FXA-350
Wattage (W)*	70W	100W	135W	200W	350W
Lumens (lm)	8900	13,300	18,000	26,200	50,000
Efficacy (LPW)	127	133	133	131	137
Equivalency (HID)	250W	250W-400W	400W	400W	750W-1000W
Distribution	Medium Narrow (4Hx4V), Wide (7Hx6V)				
Mounting	Trunnion, Slipfitter (Yoke - 350W Only)				
CCT (K)	4000K, 5000K				
CRI	≥70				
Input Voltage	120-277VAC, 50/60Hz, 347-480VAC Option, 1-10V Dimming				
Operating Temp	-40°C to 40°C (-40°F to 104°F)				
Certifications	cULus Listed for Wet Locations				
Warranty	5 Years				
Weight*	7.4 lbs	9.2 lbs	13.4 lbs	14.4 lbs	31.3 lbs

* Nominal wattage. Tested at 5000K CCT. Values at 120/277VAC. See performance table for more detailed lumen information.

Note: Environment and application will affect performance. Typical values and 25°C used for testing. Specifications subject to change without notice.

- Operating temperatures: -40°C to 40°C (-40°F to 104°F)

Ordering Information (Example: FXA-200-W-VS-5K-BR-TR)

See [FXA 15-45W](#) spec for lumens packages from 2000 to 5650 lumens

Series	Wattage	Distribution	Input Voltage	CCT	Finish	Mount	Options (Factory Installed)
FXA	70 = 70 Watts	MN ² = Med Narrow (4Vx4H)	VS = 120-277VAC	4K = 4000K	BR = Bronze	TR = Trunnion	PC = Button Photocontrol 120/277VAC
	100 = 100 Watts	W = Wide (7Vx6H)	HVS ³ = 347/480VAC	5K = 5000K		YK ⁴ = Yoke	
	135 = 135 Watts						
	200 = 200 Watts						LiteLogic Accessories⁵ (Field Installed)
	350 ¹ = 350 Watts						LE-FXA-BL-KIT⁶ = Bluetooth Enabled Dimming Occupancy Sensor, PIR, Black Finish
Notes							LE-FXA-BL-12V-KIT⁷ = Bluetooth Enabled Dimming Occupancy Sensor, PIR, Includes 12V Power Adapter, Black Finish
¹ Only available with yoke mount							PCU = Button Photocontrol 120/277VAC
² Only available for 135W-350W configurations							
³ Not available for 100W configuration							Accessories⁵ (Field Installed)
⁴ Yoke mount available for 350W model only							FXA-SF = Slipfitter Mount (for 70W-200W)
⁵ Order as a separate line item							AXL2-80/280-W90 = Wall Mount Bracket, 90°
⁶ For 70W, 135W and 200W models only							AXL2-80/280-BD = Double 180° bullhorn mount
⁷ For 100W and 350W models only							WM-T-S-BR = Wall Mount Bracket

Performance

Model	Wattage (W)	CCT	Distribution	Lumen Output	Efficacy (LPW)	CRI	Equivalency (HID)
FXA-70-W-VS-4K	70W	4000K	Wide (7Vx6H)	8900	127	70	250W
FXA-70-W-VS-5K	70W	5000K	Wide (7Vx6H)	8900	127	70	
FXA-100-W-VS-4K	100W	4000K	Wide (7Vx6H)	13300	133	70	250W-400W
FXA-100-W-VS-5K	100W	5000K	Wide (7Vx6H)	13300	133	70	
FXA-135-MN-VS-4K	135W	4000K	Medium Narrow (4Vx4H)	18000	133	70	400W
FXA-135-MN-VS-5K	135W	5000K	Medium Narrow (4Vx4H)	18000	133	70	
FXA-135-W-VS-4K	135W	4000K	Wide (7Vx6H)	18000	133	70	
FXA-135-W-VS-5K	135W	5000K	Wide (7Vx6H)	18000	133	70	
FXA-200-MN-VS-4K	200W	4000K	Medium Narrow (4Vx4H)	26500	133	70	400W
FXA-200-MN-VS-5K	200W	5000K	Medium Narrow (4Vx4H)	26500	133	70	
FXA-200-W-VS-4K	200W	4000K	Wide (7Vx6H)	26200	131	70	
FXA-200-W-VS-5K	200W	5000K	Wide (7Vx6H)	26200	131	70	
FXA-350-MN-VS-4K	350W	4000K	Medium Narrow (4Vx4H)	49500	141	70	750W-1000W
FXA-350-MN-VS-5K	350W	5000K	Medium Narrow (4Vx4H)	50000	143	70	
FXA-350-W-VS-4K	350W	4000K	Wide (7Vx6H)	49500	141	70	
FXA-350-W-VS-5K	350W	5000K	Wide (7Vx6H)	50000	143	70	

Slipfitter Accessory



Sample Photometry

FXA-200-W-VS-5K

IES: TYPE I Very Short
 MOUNTING HEIGHT: 10'
 TILT: ZERO
 HORIZONTAL SPACING CRITERIA: 1.14

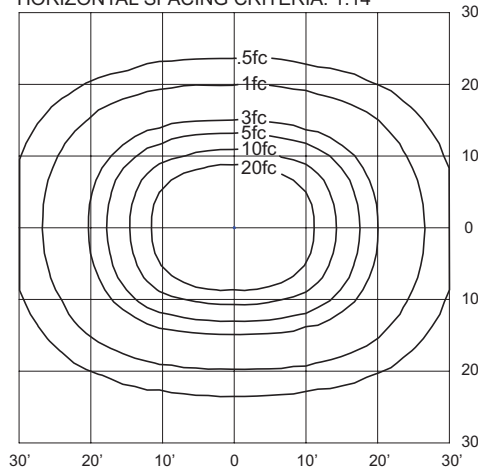

FXA-200-MN-VS-5K

IES: TYPE VS Very Short
 MOUNTING HEIGHT: 10'
 TILT: ZERO
 HORIZONTAL SPACING CRITERIA: 0.44

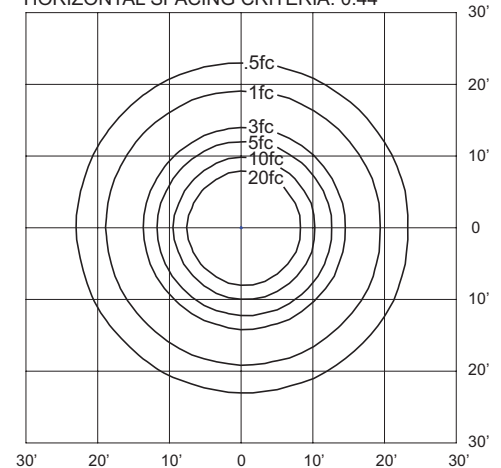

Specifications are subject to change without notice.
 Installation must be performed in accordance with
 Barron Lighting Group installation instructions.

Sensor Details - Bluetooth Enabled (Accessories LE-FXA-BL-KIT and LE-FXA-BL-12V-KIT) [Click here for sensor details](#)

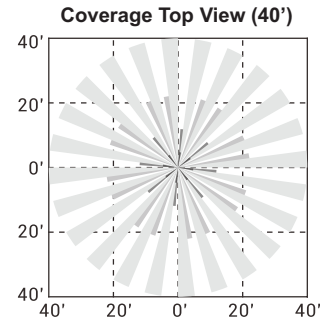
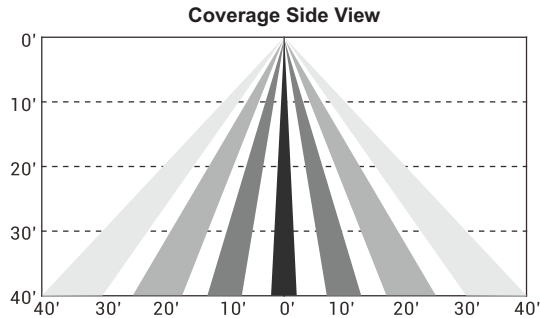

SEE APP FOR
SENSOR SETTINGS

For a complete list of LiteLogic compatible products, [click here](#).





Get it from the
App Store



Get it from
Google Play

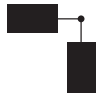

Fixture EPA Values

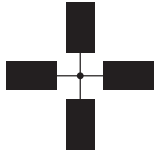
					
Model	1	2 @ 90°	2 @ 180°	3 @ 90°	4 @ 90°
70W/100W	0.2885	0.6097	0.577	0.8982	0.8982
135W/200W	0.3868	0.8125	0.7736	1.1993	1.1993
350W	0.536	1.061	1.072	1.597	1.597

Dimensions

70W & 100W

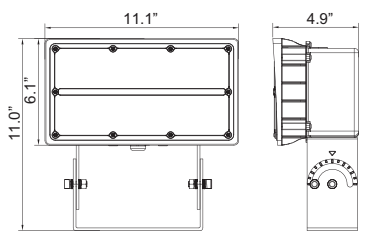

135W & 200W

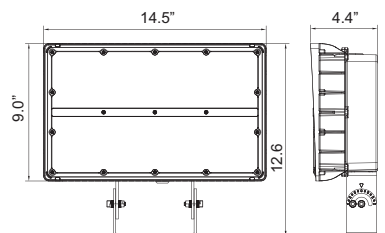

350W

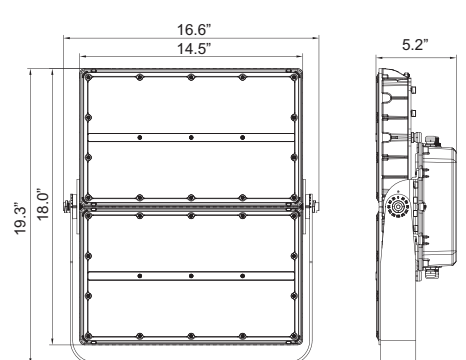

Additional Accessories and Mounts

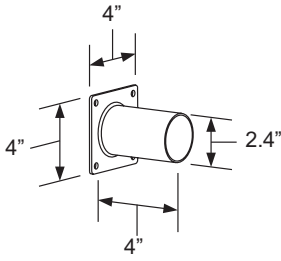

Wall Mounting Bracket
AXL2-80/280-W

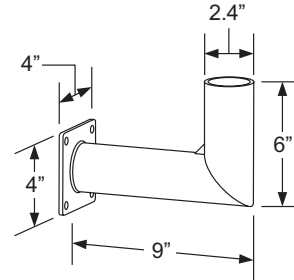

90° Wall Mounting Bracket
AXL2-80/280-W90

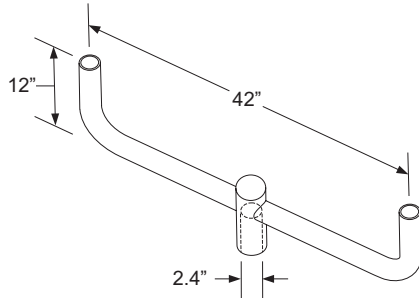

Double 180° Bullhorn Mounting Bracket
AXL2-80/280-BD
EPA Value = 1.4 square feet