



For the complete line of specialtyLED® products, visit us online at barronltg.com or call 800.533.3948.

Model: _____ Date: _____
Accessories: _____
Job Name: _____ Type: _____

XFMR-277-XX-30

30W · 277V SINGLE OUTPUT LED POWER SUPPLY



FEATURES

- Universal AC input / Full range (Up to 295VAC)
- Protections: short circuit/overload/over voltage/over temperature
- Built in constant current limiting circuit with adjustable OCP level
- IP64 design for indoor or outdoor installations
- Built-in active PFC function
- Pass LPS
- Class II power unit, no FG
- Cooling by free air convection
- 100% full load burn-in test
- High reliability
- Suitable for LED lighting and moving sign applications ^{Note: 1}
- Compliance to worldwide safety regulations for lighting
- Suitable for dry/damp locations
- 2 year warranty

SPECIFICATION

	Model	XFMR-277-12-30	XFMR-277-24-30	
OUTPUT	DC VOLTAGE	12V	24V	
	LED OPERATION VOLTAGE ^{Note: 4}	8.4 ~ 12V	16.8 ~ 24V	
	RATED CURRENT	2.5A	1.25A	
	CURRENT RANGE	0 ~ 2.5A	0 ~ 1.25A	
	CURRENT ADJ. RANGE	75% ~ 100%		
	RATED POWER	30W	30W	
	RIPPLE & NOISE (max.) ^{Note: 1}	2Vp-p	2.6Vp-p	
	VOLTAGE ADJ. RANGE	-5% ~ 10%. Can be adjusted by internal potentiometer SVR1		
	CURRENT ADJ. RANGE	3% ~ -25%. Can be adjusted by internal potentiometer SVR2		
	VOLTAGE TOLERANCE ^{Note: 2}	±10%		
	LINE REGULATION	±3.0%		
	LOAD REGULATION	±5.0%		
SETUP TIME	2300ms/230VAC, 500ms, 3000ms/115VAC at full load			
INPUT	VOLTAGE RANGE ^{Note: 3}	90 ~ 295VAC	127 ~ 417VDC	
	FREQUENCY RANGE	47 ~ 63Hz		
	POWER FACTOR	PF>0.95/115VAC, PF>0.9/230VAC, PF>0.9/277VAC at full load (Please refer to "Power Factor Characteristic" curve)		
	EFFICIENCY(Typ.)	82.5%	84%	
	AC CURRENT	0.4A/115VAC	0.2A/230VAC	0.15A/277VAC
	INRUSH CURRENT(max.)	COLD START 35A(twidth=25µs measured at 50% Ipeak) at 230VAC		
	LEAKAGE CURRENT	<0.5mA/240VAC		
PROTECTION	OVER CURRENT	100 ~ 110% rated output power		
	SHORT CIRCUIT	Constant current limiting, recovers automatically after fault condition is removed		
	OVER VOLTAGE	14 ~ 16V	27 ~ 34V	
		Shut off o/p voltage, re-power on to recover		
	OVER TEMPERATURE	Shut down o/p voltage, recovers automatically after temperature goes down		

SPECIFICATIONS ARE SUBJECT TO CHANGE WITHOUT NOTICE

SPECIFICATION (cont.)

	Model	XFMR-277-12-30	XFMR-277-24-30
ENVIRONMENT	WORKING TEMP.	-22 ~ +122°F (Refer to "Derating Curve")	
	WORKING HUMIDITY	20 ~ 95% RH non-condensing	
	STORAGE TEMP., HUMIDITY	-40 ~ +176°F , 10 ~ 95% RH	
	TEMP. COEFFICIENT	±0.06%/°F (0 ~ 122°F)	
	VIBRATION	10 ~ 500Hz, 2G 10min./1cycle, period for 60min. each along X, Y, Z axes	
SAFETY & EMC	SAFETY STANDARDS	Meets UL879, meets UL1310, meets CSA C22.2 No. 207-M89, TUV EN61347-1, EN61347-2-13, meets CAN/CSA C22.2 No.223-M91,IP64, J61347-1,J61347-2-13 approved	
	WITHSTAND VOLTAGE	I/P-O/P:3.75KVAC	
	ISOLATION RESISTANCE	I/P-O/P:>100M Ohms / 500VDC / 77°F / 70% RH	
	EMC EMISSION	Compliance to EN55015, EN61000-3-2 Class C (pin≥25W), Class D (>70% load); EN61000-3-3	
	EMC IMMUNITY	Compliance to EN61000-4-2,3,4,5,6,8,11, EN55024, EN61547, light industry level, criteria B	
OTHERS	MTBF	621.4Khrs min. MIL-HDBK-217F(77°F)	
	DIMENSIONS	5.7in * 1.85in * 1.18in (L*W*H)	
	PACKING	0.48lbs; 60pcs/31.3lbs/1.25CUFT	

NOTES

1. Ripple & noise are measured at 20MHz of bandwidth by using a 12" twisted pair-wire terminated with a 0.1uf & 47 uf parallel capacitor.
2. Tolerance: includes set up tolerance, line regulation and load regulation.
3. Derating: may be needed under low input voltage, please check the static characteristic for more details.
4. Constant current operation region is within 75%~ 100% rated output voltage. This is the suitable operation region for LED related applications, but please reconfirm special electrical requirements for some specific system design.

ATTENTION

- All parameters NOT specifically mentioned are measured at 230VAC input, rated load and 77°F ambient temperature.
- Please refer to the "DRIVING METHODS OF LED MODULE"
- The power supply is considered as a component that will be operated in combination with final equipment. Since EMC performance will be affected by the complete installation, the final equipment manufacturers must re-qualify EMC Directive on the complete installation again.
- Direct connecting to LEDs is suggested, but is not suitable for using additional drivers.

MECHANICAL SPECIFICATION

CASE NO. 964A UNITS: INCHES

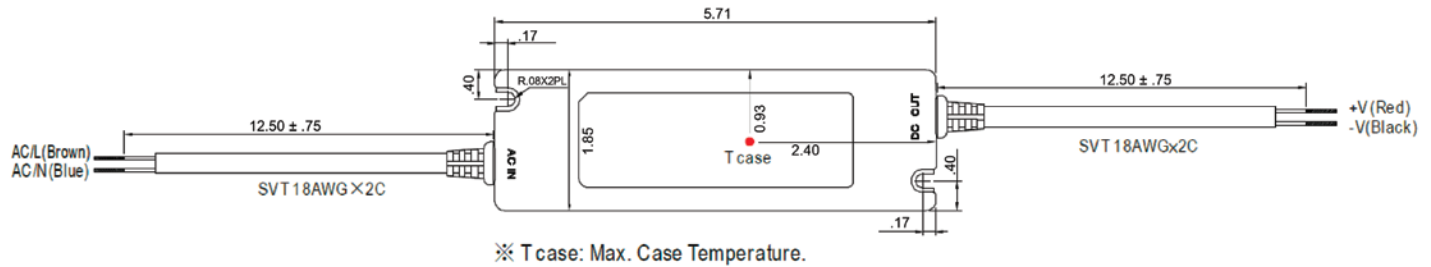

Output voltage and current adjustment : remove the upper case and adjust through SVR1 & SVR2 shown in the diagram.

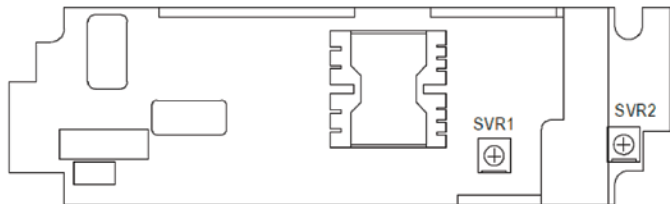

SVR1	Output voltage adjustment
SVR2	Output current adjustment

BLOCK DIAGRAM

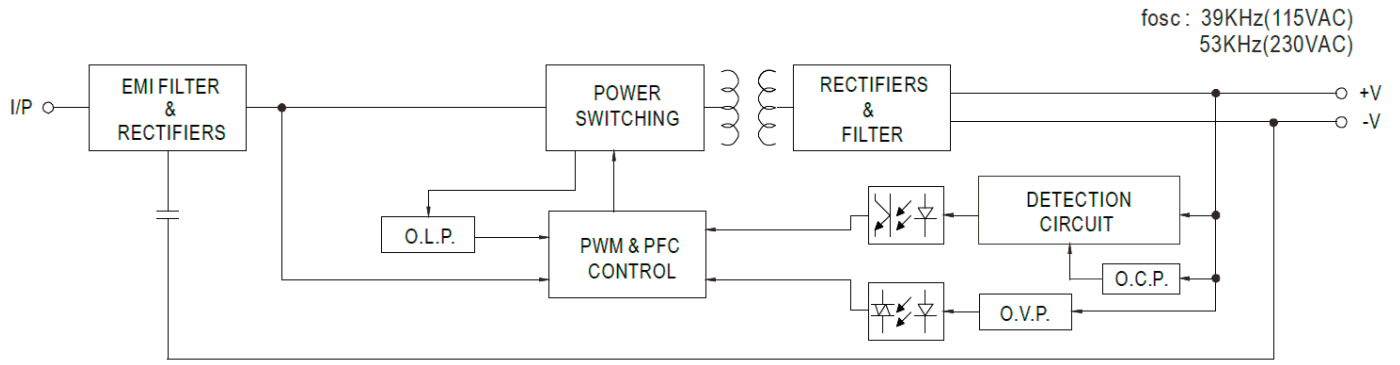

DERATING CURVE

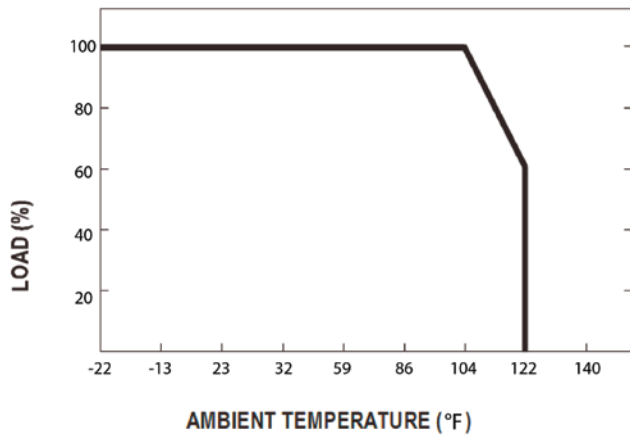

STATIC CHARACTERISTICS

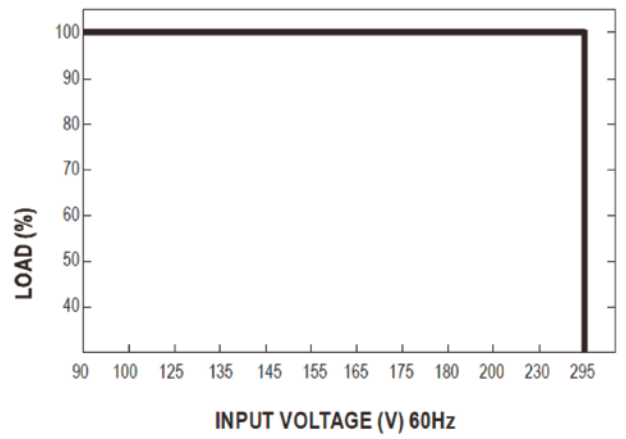

POWER FACTOR CHARACTERISTIC

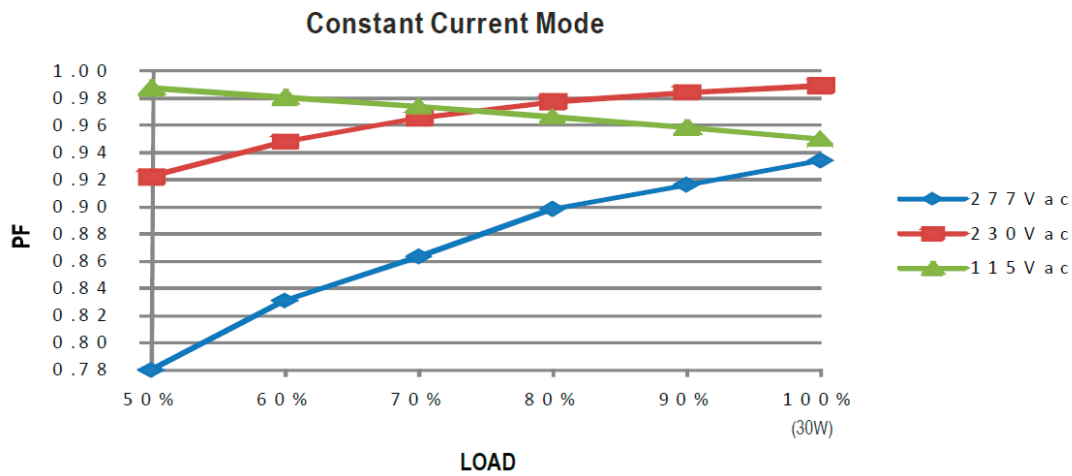

DRIVING METHODS OF LED MODULE

This LED power supply is suggested to work in constant current mode area (CC) to drive the LEDs.

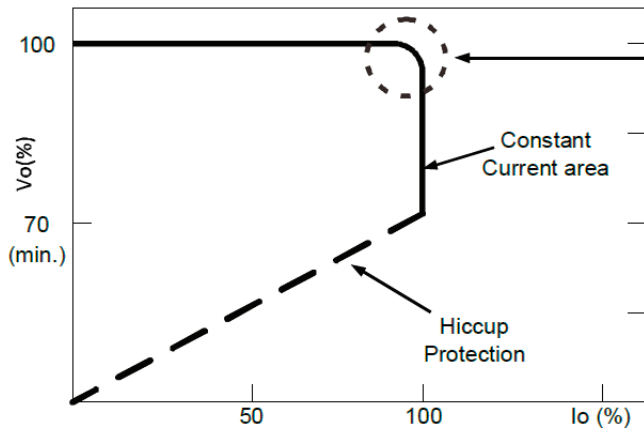

In the constant current region, the highest voltage at the output of the driver depends on the configuration of the end systems.

Should there be any compatibility issues, please contact factory.

Typical LED power supply I-V curve