

IMPORTANT SAFEGUARDS READ AND FOLLOW ALL SAFETY INSTRUCTIONS.

When using electrical equipment, basic safety precautions should always be followed including the following:

DISCONNECT AC POWER SUPPLY BEFORE SERVICING.

- Installation and servicing of this equipment should be performed by qualified service personnel.
- Ensure that the electrical wiring conforms to the National Electrical Code NEC® and local regulations if applicable.
- Do not mount near gas or electrical heaters.
- Equipment should be mounted in locations and at heights where it will not be readily subjected to tampering by unauthorized personnel.
- The use of accessory equipment not recommended by the manufacturer may cause an unsafe condition.
- Any modification or use of non-original components will void the warranty and product liability.
- Do not use this equipment for other than intended use.
- May be used in outdoor covered environment with temperatures ranging from 10°C to 40°C (50°F to 104°F)

SAVE THESE INSTRUCTIONS!

Use Flexible Conduit Only

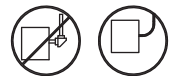

Wall Mount

1. Use flat head screwdriver to loosen the screws on the lens.
2. Remove lens from sign and set aside for later use.
3. Remove the EXIT stencil from housing and set aside.
4. Drill out the desired mounting knockouts found on the backplate to fit the junction box mounting dimensions.
5. Drill or knock-out the center wire access hole on the backplate for the unit's supply wire leads.
6. Remove the backing from self adhesive junction box gasket and adhere to the backplate.
7. Route the unit's input wires through center wire access hole of the backplate and make wiring connection (see **Electrical Connections** section).
8. Secure backplate to junction box using the correct hardware (supplied by others).
9. Remove desired chevron(s) as needed. **Note:** When removing chevrons it may be helpful to remove the color diffuser panel to allow easier access to the chevrons. Once chevrons have been successfully removed it is important to reinstall the diffuser panel.
10. To prevent battery damage: Do not connect the battery until constant AC power can be supplied to the unit.
11. Secure faceplate(s) to the housing.
12. Secure lens to faceplate.
13. Press "TEST" button to check operation.

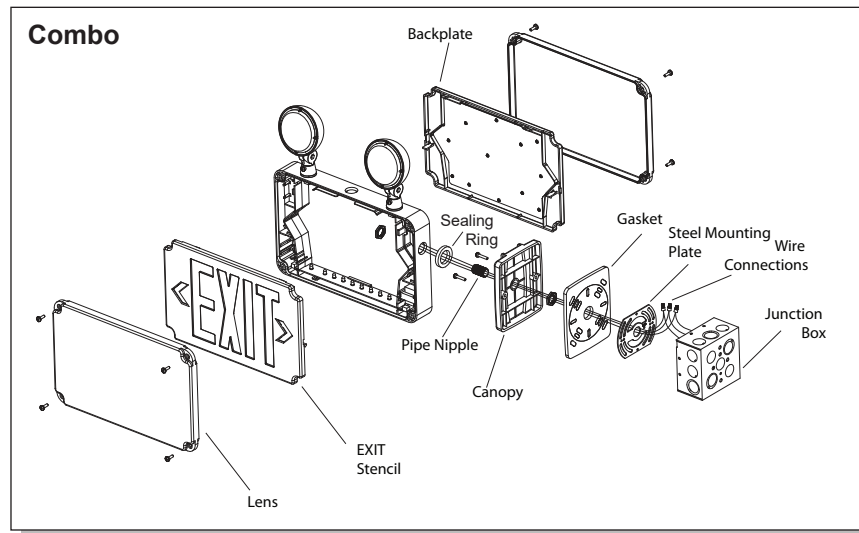

End Mount

1. Use flat head screwdriver to loosen the screws on the lens.
2. Remove lens from sign and set aside for later use.
3. Remove EXIT stencil from housing and set aside.
4. Drill a 3/4" hole through the mounting knockout located on the side of the housing.
5. Using provided hardware, thread nut onto pipe nipple. Slide pipe nipple through canopy center hole.
6. Remove backing from self adhesive junction box gasket and adhere to back of mounting canopy.
7. Place screws (provided) in holes on the canopy.
8. Route EXIT input wires through knockout in EXIT frame, pipe nut and metal mounting plate.
9. Make electrical connections - See **Electrical Connection** section.
10. Route wire connections into the junction box.
11. Secure mounting plate to the junction box (hardware not included).
12. Secure the canopy to the steel mounting plate with screws installed in step 7.
13. Place pipe nipple through the mounting hole of the housing until the sealing ring is touching the housing frame. Thread a second nut onto the pipe nipple on the inside of the housing to lock the canopy into place. Once canopy is locked into position there should be no side-to-side movement of the canopy.
14. Remove desired chevron(s) as needed. **Note:** When removing chevrons it may be helpful to remove the color diffuser panel to allow easier access to the chevrons. Once chevrons have been successfully removed it is important to reinstall the diffuser panel.
15. To prevent battery damage: Do not connect the battery until constant AC power can be supplied to the unit.
16. Secure faceplate(s) to the housing.
17. Secure lens to faceplate.
18. Press "TEST" button to check operation.

Conduit Entry

1. Drill a 3/4" hole through the desired conduit entry.
2. Route the AC input conduit into housing.
3. All conduit connections must use UL listed and suitable for wet location parts.
4. To finish installation of EXIT sign reference **Wall** or **End Mount** section.

Operation

1. Once AC power is supplied to the unit the red LED indicator will be activated.
2. After the battery has been allowed to charge for 2 hours, test the unit by pushing the button. The LED indicator will turn off and the EXIT sign will remain illuminated.
3. When the test button is released, the LED indicator will return to red.

Maintenance

Battery should be tested periodically by performing a 90 minute discharge and replaced when it no longer operates for the duration of 90 minutes. The battery supplied in this sign has a life expectancy of 5 years when used in a normal ambient temperature of 25°C (77°F).

Electrical Connections

All electrical connections should be made inside junction box.

Make electrical connections as follows:

- White - Common
- Black - 120V
- Red - 277V

Note: Cap unused leads to prevent shorting.

Standard Wiring Diagram

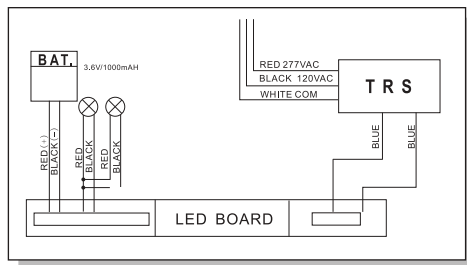

Remote Wiring Diagram

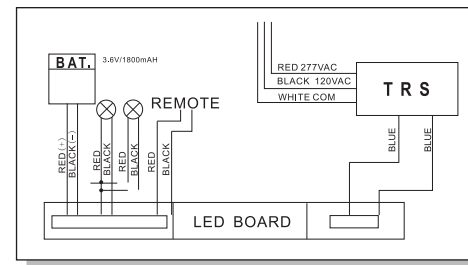

See last page for **Wet location installation.**

WET locations Installation

1. Seal ring

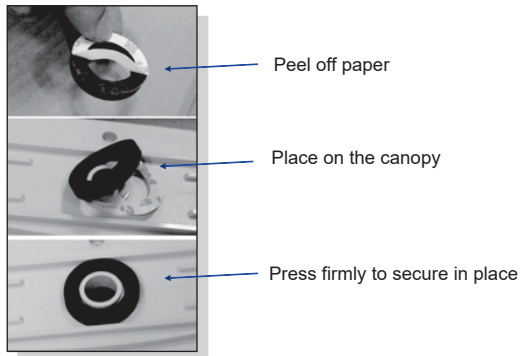

2. Attaching Canopy

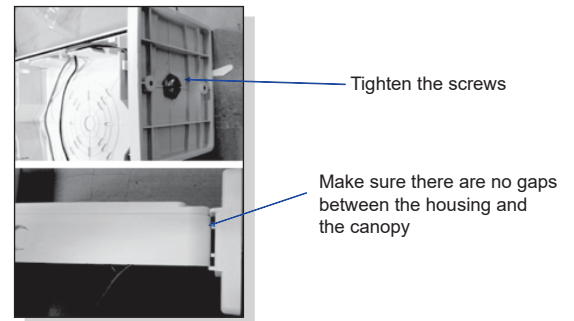

3. Clear lens

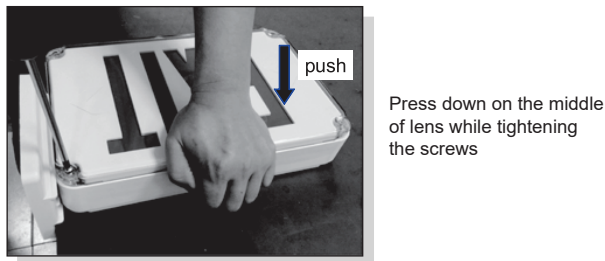

4. Seal foam installation

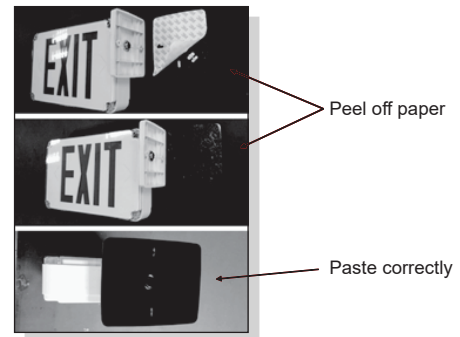

5. Final

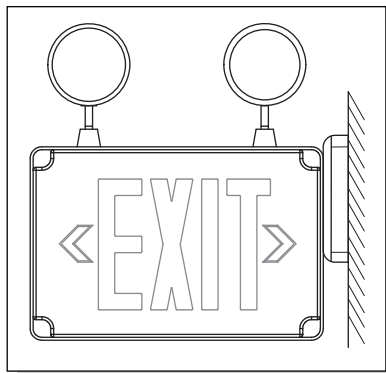

6. Adjust the angle of the lamp head and tighten the locking screws.

WARNING: Press the unit to make sure it is locked to the wall securely. Distance between canopy and wall should be less than 2mm.